

# ESP II 24/48/60

L i g h t i n g   C o n t r o l   C o n s o l e s

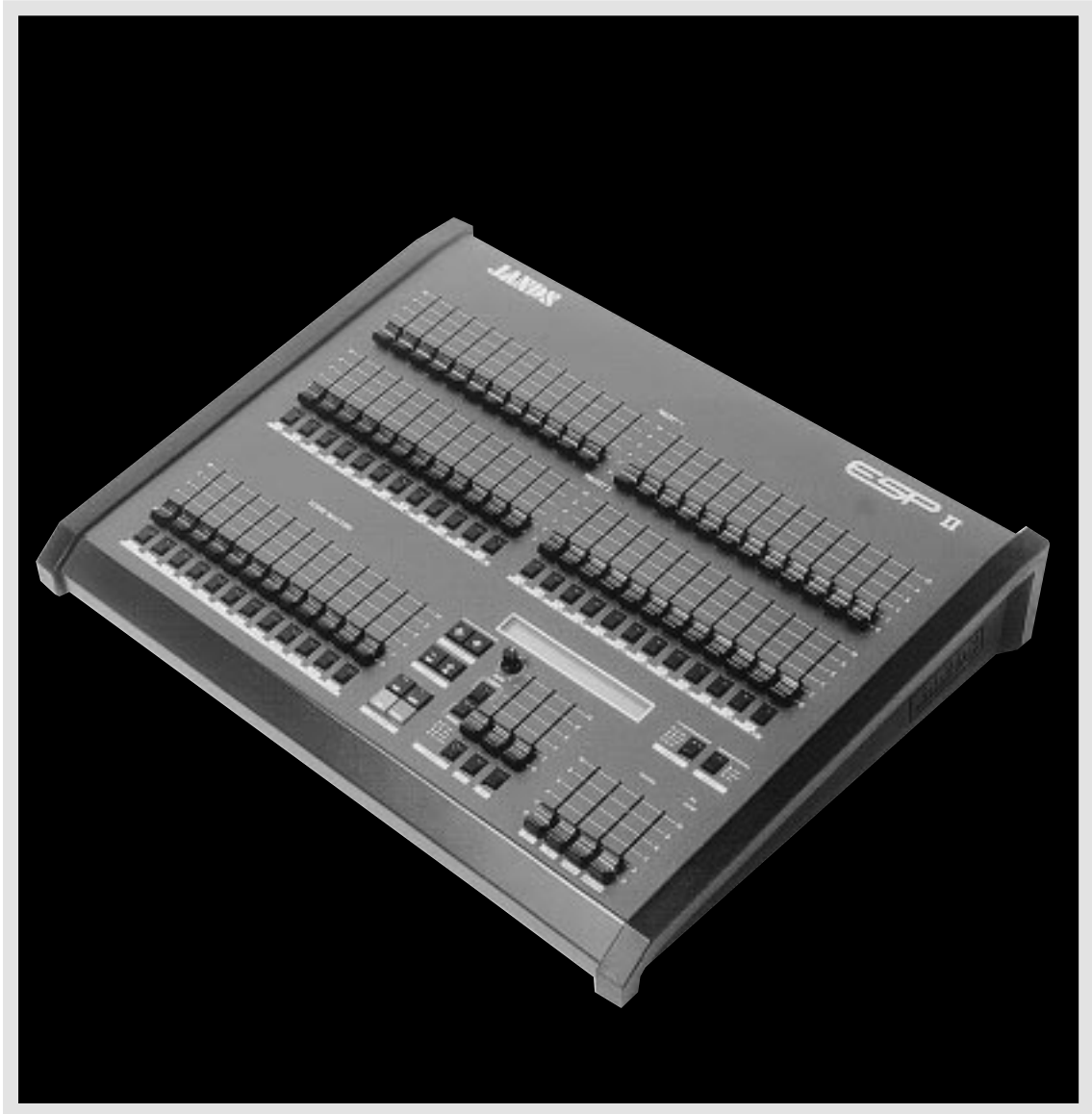

# OPERATING MANUAL

**JANDS**

---

©1992 Jands Electronics

This instruction manual and the software described in it are copyrighted, with all rights reserved. Under the copyright laws, this manual or the software may not be copied, in whole or part, without the written consent of Jands Electronics.

#### Technical Help and Support

If you have queries regarding the use of the ESP II or any other Jands product, please contact us at:

Phone      Australia (2) 9582 0909  
                 9am and 5pm Australian Eastern Standard Time

Fax          Australia (2) 667 4764

Email        [info@jands.com.au](mailto:info@jands.com.au)



---

*Jands Electronics Pty Ltd  
578 Princess Hwy  
St Peters, NSW, AUSTRALIA  
Phone +61 2 516 3622  
Fax +61 2 517 1045*

---

---

# Table of Contents

<b>Getting Started</b> .....	<b>4</b>
<b>Description of Major Parts</b> .....	<b>6</b>
Using Presets .....	10
Using Flash Buttons .....	11
Using the Master Controls .....	12
Using the Function Buttons .....	14
The LCD Display Window .....	15
<b>Setup</b> .....	<b>16</b>
Patch .....	17
Desk .....	19
Linking Desks .....	19
LCDs .....	22
Utility .....	23
Midi .....	25
MCard .....	27
<b>Working with Scenes</b> .....	<b>28</b>
Editing Scenes .....	30
<b>Working with Chases</b> .....	<b>32</b>
Editing Chases .....	35
<b>Working with FX</b> .....	<b>38</b>
Editing FX .....	40
<b>Working with XF Cues</b> .....	<b>42</b>
Editing Xf Cues .....	44
<b>Reset</b> .....	<b>47</b>
<b>Appendix</b> .....	<b>48</b>
<b>Index</b> .....	<b>52</b>

---

# Getting Started

## **Connecting Power**

Plug the socket end of the power cord into the IEC power receptacle located on the rear face of the ESP II. The other end of the power cord should be plugged into a 3 pin grounded outlet. It is important that the ESP II is electrically grounded, if in doubt about whether or not an outlet is grounded contact a licensed electrician.

## **Connecting the Output to a dimmer**

ESP II provides two methods of connection to dimmer systems. The DMX output is standard on all consoles. Optional Socapex output panels can be simply fitted to the console to provide 0 - 10v wire-per-channel outputs.

- **DMX-512 Output**  
Connect from the consoles DMX output to the DMX input on the dimmer rack, check the dimmer instruction manual for details on selecting DMX Channels and looping the DMX line to other dimmer racks.  
Up to 512 dimmer channels can be controlled in this way.
- **Analogue Outputs (Optional)**  
Connect from the consoles Socapex outputs to the dimmer rack input  
Up to 8 Socapex connectors can be fitted to a console to provide up to 240 dimmer channels

## **Connecting Desklights**

Desklights are available as an optional accessory. Only Littlelite or compatible desklights with 3 pin Cannon type connectors should be used.

---

# Description of Major Parts

## General Description of Major Parts

The front panel of the ESP II lighting control console is divided into 4 main areas. The top section consists of the Preset faders (A) and flash buttons (B) which can be used both for direct control and recording. The lower left section consists of the (C) Scene Master faders (D) and Scene Flash buttons (E). The lower mid section consists of the LCD display (F), the Function buttons (G) the Chase controls (H), the FX controls (I) and the Xfade controls (J). The lower right section consists of the Master controls for Preset 1, Preset 2, (K) Flash Buttons (L) and the Grand Master (M).

The rear panel of the ESP II houses all the input and output connections for power, control signals and desklights.

### A The Preset Faders

Are used to set up channel levels both in operation and while recording. It's possible to run a show entirely on the Presets but generally these controls are used for programming or to make impromptu changes to the stage lighting.

### B The Flash Buttons (Channel)

Are used to momentarily flash on a channel. There is a flash button for each channel when the desk is operating in the normal 2 preset mode. However if the console is set to Wide mode, only the first half has flash buttons.

Event is available with 24 and 48 Channels. The console can be set to wide mode which doubles the number of channels

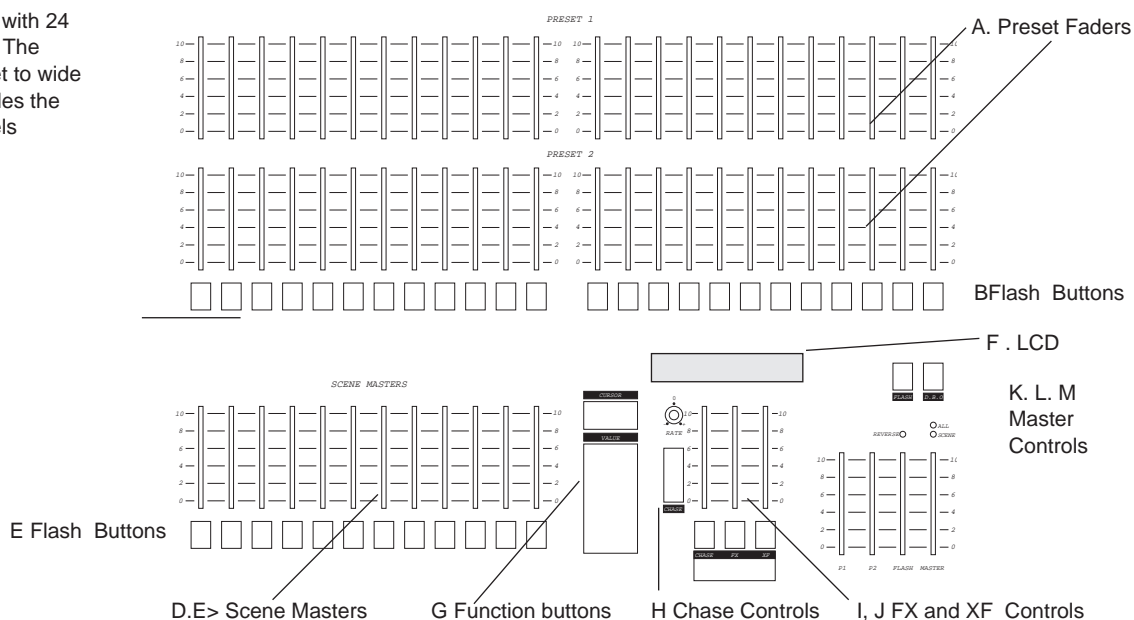

---

## Description of Major Parts

### D Scene Master Faders

The Scene Masters are used to fade Scenes up and down. They also control Chases that have been Assigned to a Scene Master.

### E The Scene Flash Buttons

These buttons are used to momentarily flash on a Scene (or Chase).

### F The LCD Display

The backlit LCD screens display the current Page, Chase, FX and Xfade settings. It is also used to display various menus during editing and console setup.

### G The Function Buttons

There are 8 buttons:

Left and Right Arrow - move the cursor in the LCD.

Plus (+) and Minus(-) - change values for Page, Chase, etc.

Edit - Press and hold Edit then press a Flash button to open the Edit menu

Setup - Press to open the Setup menus.

Exit - Press to close a menu.

Record - Press and hold Record then press a Flash button to Record a Scene, Chase, FX or Xf.

### H The Chase Controls.

There are five controls in the Chase section:

A level fader

A Flash button which is used to run one cycle of the chase pattern and to single step a stopped chase.

A rotary rate control

A direction button

An Assign button - Press the Assign switch then any Scene Flash button to assign a Chase to the control of a Scene Master.

### I The FX controls (Effects)

Intended for use in controlling color scrollers. The fader controls the FX level while the Flash button is used to step through the FX. Up to 100 FX can be recorded.

### J The Xfade controls (Crossfades)

These controls are used to run timed crossfades. The fader controls the fade rate while the Flash button is used as the cue GO button. A cue consists of an Xfade number (0-9) and a Q number (0-99).

---

## Description of Major Parts

- K P1 and P2 Masters  
These 2 faders scale the level of the top (P1) and bottom (P2) presets.
  
- L Flash Master Controls  
The Flash Master fader scales the level of the flash buttons. The Add / Solo switch above this fader sets the method of operation for the flash buttons.
  
- M Grand Master  
Scales the level of all outputs (except the flash buttons).
  
- K Power Input  
Consists of an IEC power input complete with fuse and on/off switch.
  
- L Desklight Outlets  
Designed for use with Littelite or compatible desk lamps
  
- M DMX Output  
Control output for connection to dimmer systems or interfaces using DMX-512 protocol
  
- N Midi  
Control input allowing Midi signals to control various functions of the console.



---

---

# Using Presets

## **Preset Controls**

The preset controls can be used to set up desired lighting levels both in operation and while recording. It's possible to run a show entirely on the Presets but generally these controls are used for recording or to make impromptu changes to the stage lighting.

## **Channel Preset Faders**

There are 2 rows of preset faders on the ESP II, the top row of faders is Preset 1 and the bottom row is Preset 2, these faders can be used to smoothly fade a light to the desired level. The output level produced by the preset faders is dependent on the level of the Grand Master and the P1 (or P2) fader.

## **Example**

Bring the Grand Master and P1 Master faders to 10 (100%).

Move the Channel 1 Preset fader to 100% and you should see the lights connected to that channel fade up to full level.

Now fade up Channel 2 to 5 (50%), check that the lights connected to channel 2 are at about 1/2 level.

Finally fade the P1 Master down and Up to see how it scales the Channel Preset faders.

## **More Information.**

Pg 20 Using all Preset faders as a single preset to obtain double the number of channels

Pg 23 Reversing the P2 fader to provide 100% output when positioned at 0

---

## Using Channel Flash Buttons

### **Channel Flash Buttons**

These buttons correspond to the Channel faders and perform two functions:

- 1 Flash. The buttons are used to momentarily flash on a channel. The type of operation (add, solo, latch) of the flash button depends on the setting of the Add / Solo master switch
- 2 Inhibit. To prevent a channel from appearing in any output, hold the Flash button down and press the DBO button. Repeat this procedure to cancel inhibit.

---

## Using Masters Controls

### **P1 and P2 Faders**

The P1 Master Fader scales the top row of preset faders, likewise the P2 Master Fader scales the overall level of the bottom row of preset faders. By moving the P1 fader up while moving the P2 fader down it's possible to crossfade between the settings on the 2 rows of channel preset faders.

### **Add / Solo Master Switch**

The Flash buttons can be set to operate in 3 different ways or turned off completely. To change the operation of the flash buttons press the Add / Solo switch. With each press of the button the 2 leds within the switch change to indicate which mode has been selected.

- Add - Indicated by the Green Led being on. Pressing a FLASH button causes that output to flash instantly to the level set by the Flash Master fader.
- Add Latch - Indicated by the Green Led Flashing. The Flash buttons push-on and push-off instead of flashing. When a Flash button is latched on, the Channel LED will flash synchronously with the Add / Solo switch LED. If Add Latch is disabled while some channels are Latched, the channels will unlatch but will not become latched again if Add Latch is subsequently enabled.
- Solo - Indicated by the Red Led being on. Pressing a Flash button causes that output to flash instantly to the level set by the Flash Master fader, while at the same turning off all other desk output.
- Disabled - Indicated by neither Led being on. Pressing a channel Flash button has NO effect.

### **Add / Solo Fader**

This fader scales the intensity of the flash buttons.

### **Grand Master Fader**

Scales the intensity of all console outputs except the flash buttons.

### **D.B.O. Switch**

This button performs two functions:

- 1 Blackout. Press to black out the output of the console. The button can be set to momentary or latching operation.
- 2 Inhibit. To prevent a channel from appearing in any output, hold a channel Flash button down and press the DBO button.



**Masters Controls**

---

## The Function Buttons

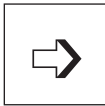
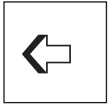

### The Cursor Buttons

The left arrow and right arrow buttons are used to move the cursor to the various fields in the LCD display window.

O

N

### The Plus (+) On and Minus (-) Off Buttons

These buttons are used to change values. The plus button will either increase a value or change a setting from off to on. Likewise the - button will decrease values or change a setting from On to Off. These buttons are also used in a few menus to toggle between several choices. These buttons operate in three ways.

- 1 Press. The value increases by 1 with the + button or decreases by 1 with the - button
- 2 Press and Hold. The value scrolls up with the + button or down with the - button
- 3 Double Press. The value snap to the maximum for that field with the + button or to 0 with the the - button. It may take a couple of attempts to double press at a fast enough speed to see this work.



### The Edit Button

The EDIT button is used in conjunction with the Scene, Chase, FX and XF flash buttons to open the Edit menu. Hold the button down for approximately 2 seconds to show a help message.

### The Setup Button

The SETUP button is used to open the Setup Menus.

X

### The Exit Button

The EXIT button is used to close the menu. Hold the button down for approximately 2 seconds to show the ESP II software version number.

D

### The Record Button

The RECORD button is in conjunction with the Scene, Chase, FX and XF flash buttons to store levels.. Hold the button down for approximately 2 seconds to show a help message.

# LCD Window

The LCD display is used to perform two functions.

1 Normal Display.

In operation the LCD shows:

The current Page number.

The current Chase number and Step number.

The current FX number and the Next FX.

The current XF Q number and the Next XF Q.

- Changing a Setting

Use the arrow buttons to move the cursor to the required field. Use the Plus (+) and Minus (-) buttons to set the field.

- Freeze Indication

When the Page or Chase field is flashing it indicates that the Page or Chase number has been changed while the old Chase or a Scene was set above zero. That fader will not change to the new Chase or Page until it is faded to zero.

2 Menu Display.

A number of menus can be accessed to Setup the console and Edit Scenes, Chases, FX and Xf Q.

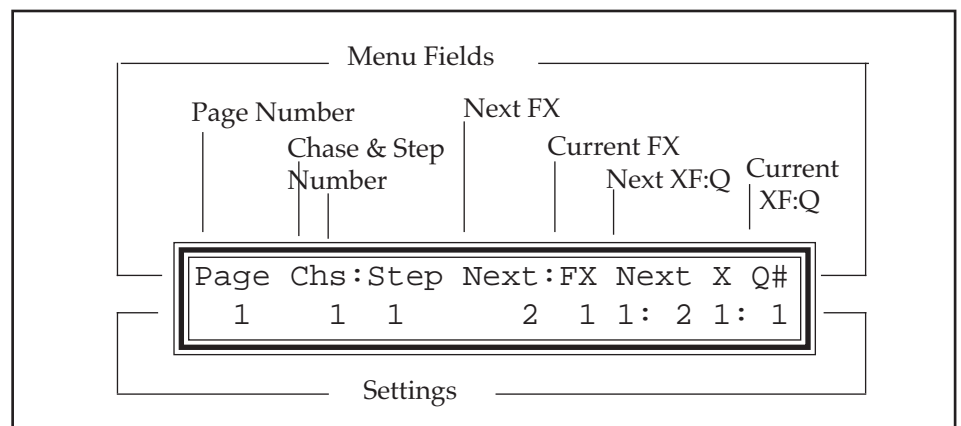

---

# Setup

Setup is used to perform various procedures which control the way the console operates. The setup menu consists of 6 top level menus, some of which have sub-menus. Some of the menus, such as PATCH and LCDs are used to customise the desk while others such as MIDI are used to extend the control capabilities of the ESP II.

When the SETUP button is pressed the Setup menu appears in the LCD window. The Setup menu is illustrated below.

To open one of the Setup menus use the arrow buttons to select a menu and then press the ON (+) buttons

The Setup Menu

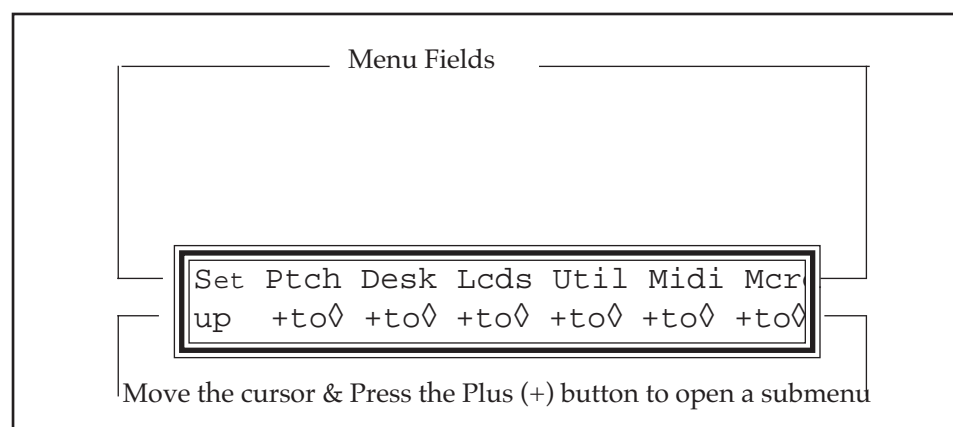



---

## Setup Patch

The ESP II will control up to 512 dimmer channels. The Setup Patch menu allows these dimmer channels to be patched in any combination and at any level to the console channels.

Example:

A Patch is setup by first setting a console Channel number then setting the Dimmer numbers to be connected to that channel. In the illustration below Console Channel 1 is set to control Dimmer 1 at 100% (FF) and Dimmer 10 at 100%. This means that when Channel 1 on the console is faded up to 100% the lights connected to dimmers 1 and 10 will fade up. The complete Patch consists of each Channel that is being used being set to control one or more dimmer numbers. Since there are 3 different Patches available (1,2 & 3) its possible to set one Patch, which includes all dimmers, for the main act and a different Patch which might not include all dimmers for the support act. Similiarly if a light was knocked out of focus during the show the Patch could be used to reduce the level of its dimmer to 0 so that the light would not come on at any time.

The Patch menu

Figure 13 illustrates the Patch menu. There are 4 fields:

The Setup Patch Menu

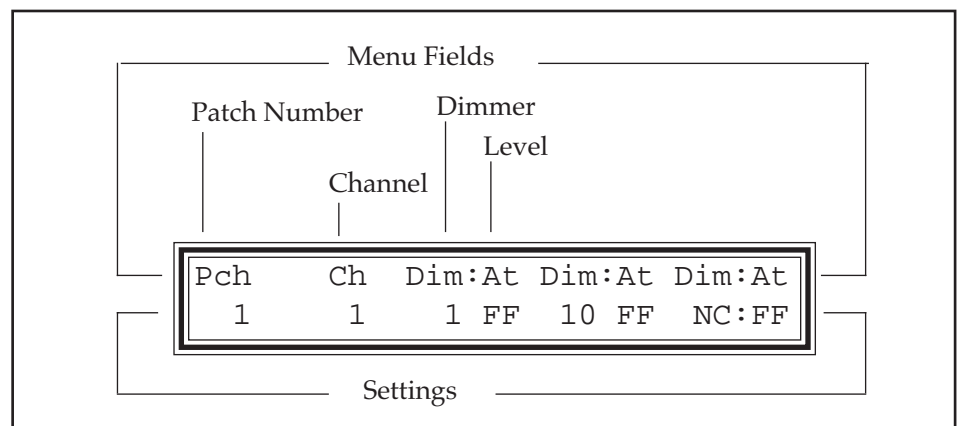

---

## Setup Patch

Pch (Patch Number)

Patch numbers range from 1 to 3. The Patch number shown is active so care should be taken in changing the Patch number while the console is in use.

Ch (Channel)

Sets the console Channel number to be patched. Only one channel can be displayed at a time.

Dim (Dimmer)

Sets a dimmer number to patch to the Channel shown in CH.

At (At Level)

Sets the level of the dimmer set in the DIM field. At can be set from 0 to FF (full).

### **The Default Patch**

The default patch on the ESP II is Patch 1, it is a one-to-one patch. That is Channel 1 connect to Dimmer 1, Channel 2 connect to Dimmer 2, and so on. Dimmer numbers above the number of console channels are not connected.

### **Patching Dimmers to Channels**

A dimmer can only be patched to one channel at a time.

### **Storing Changes made in Patch**

When all changes to a patch have been made, press the Record button to save these changes and leave the Patch menu. If you press the Exit key you are prompted to either save the changes by pressing the ON(+) button or to abandon them by pressing the OFF (-) key.

---

# Setup Desk

The SETUP DESK menu is used to configure the ESP II to suit your particular requirements and favored operating method. To open the Desk menu, press the SETUP button, move the cursor to the DESK field and press the PLUS (+) key.

## Setup Desk

The menu consists of 5 fields (one being a submenu).

### Mode

This feature is useful in protecting the ESP II against unauthorised use or in restricting an inexperienced operator.

The Mode field can be toggled between PLAY and REC (Record). In the PLAY mode it is not possible to Record, Edit or change Patch information.

### Link

It's possible to connect two ESP II consoles together by connecting a special cable from the DMX output of the Slave console to the Midi input of the Master console. For details on the wiring of this cable see the appendix.

Once the two consoles are connected the LINK menu can be used - on both consoles - to set one to Master operation and the other to Slave operation.

To open the LINK menu, press the SETUP button, move the cursor to the LINK field and press the PLUS (+) key, the Link menu consists of two fields as follows:

The Setup Desk Menu

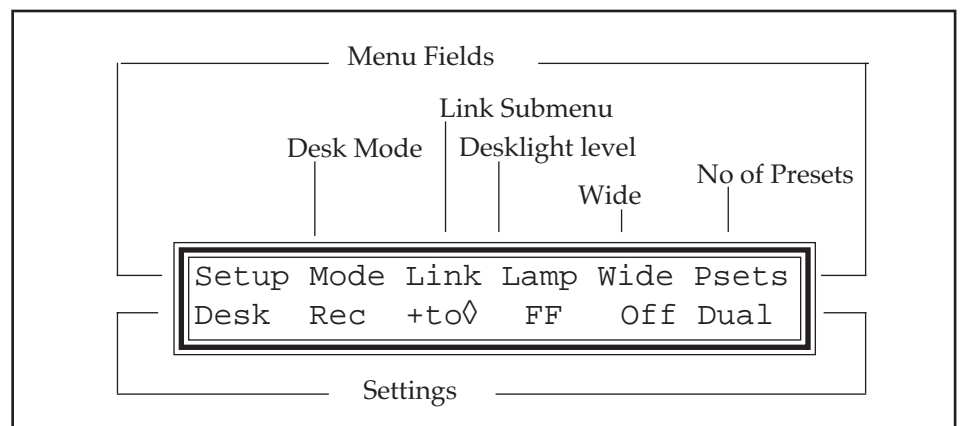

---

## Setup Desk

### Master

When the MASTER field is set ON the MIDI IN socket can be used to receive channel level information from the DMX output of a second ESP II console. To use an ESP II as a Master console it must be set to WIDE mode. If MASTER is turned on without WIDE being on a message will be displayed offering the option of resetting the desk to WIDE but this will clear the data already recorded.

When MASTER is turned ON the ESP II checks to see what extra channels are available (on the Slave console) and displays a message confirming the number of extra channels.

### Slave

When the SLAVE field is set ON the DMX socket is used to send channel level information to the MIDI input of a second ESP II console.

When a console is in Slave mode only the Preset faders and Flash buttons are active.

### Lamp (DeskLight)

The intensity of the Desklight(s) can be adjusted by setting the LAMP field from 0 (0%) to FF (100%)

To set the Desklight level press SETUP move the cursor to the DESK field; press the Plus (+) button move the cursor to the LAMP field and enter a value between 0 and FF (Full) using the + and - buttons.

### Wide

One of the most powerful features of the ESP II is its ability to work as a single preset board outputting double the number of channels normally available. In applications where Colour Scrollers or Moving Lights are being controlled this feature greatly extends the usefulness of the console. An ESP II 24, for instance could control 48 colour scrollers.

WIDE should be turned on before recording. Once a console has been set to WIDE the Preset 2 faders are used to control the higher numbered channels. For example on an ESP 48 the Preset 2 faders would control channels 49 to 96. The Preset 2 Master Fader is disabled.

### Psets

The PSETS field is used to alter the operation of the bottom Preset faders so that they can either be used as extra Preset 1 faders to control Wide mode channels or as a regular second preset.

Setting the console to WIDE automatically switches the Preset 2 faders to

---

## Setup Desk

SINGLE preset usage (i.e. the P2 faders control the extra channels). However it is possible to switch the P2 faders to operate as a normal second preset by changing the PSETS field to DUAL. In this way it's possible to Record Scenes, FX Cues and Chases using all the faders as a single preset but having done so to switch back to having two manual presets for the first half of the channels. This method is particularly useful for controlling Colour changers and other moving lights which once recorded do not need direct control.

To change the PSETS field to SINGLE (or back to DUAL) move the cursor to the PSETS field and press the ON (+) button.

Figure7  
The Setup Desk Link Menu

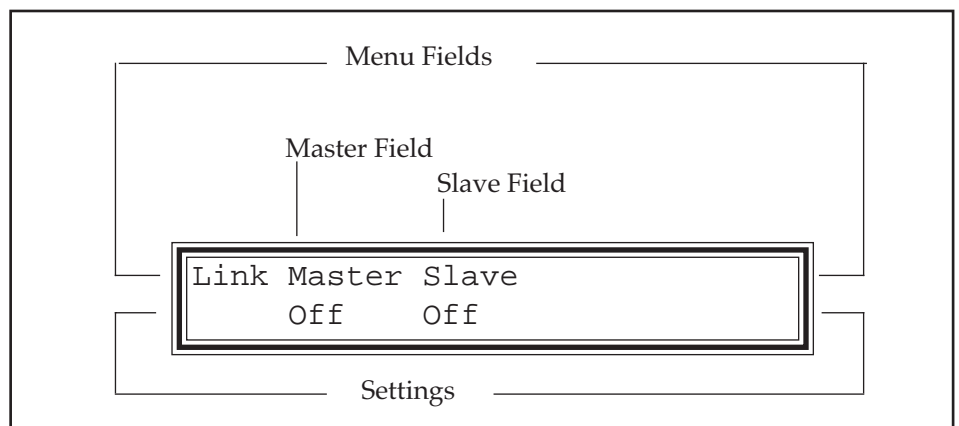

---

## Setup LCDs

The LCD located on the front panel of the ESP II can be configured to suit different lighting conditions and viewing angles.

### The LCD Menu

To open the LCD menu move the cursor to the LCD field and press the + key. The menu contains 3 fields.

#### Cursor

This field can be toggled between Block and Line by pressing the plus (+) or minus (-) button. Generally a block cursor is easier to locate in a menu.

#### Contrast

This field can be set to any value between 0 and 15 using either the numeric keypad or the + and - buttons. Higher contrast settings tend to make the LCDs more legible from lower viewing angles.

#### Bright

This field can be set to any value between 0 and 15 using either the numeric keypad or the + and - buttons. At 0 there is no backlighting of the LCDs, at 15 maximum backlighting is provided. Backlighting should always be used in low ambient light conditions but can be turned of if the console is in direct sunlight.

Figure8  
The Setup LCDs Menu

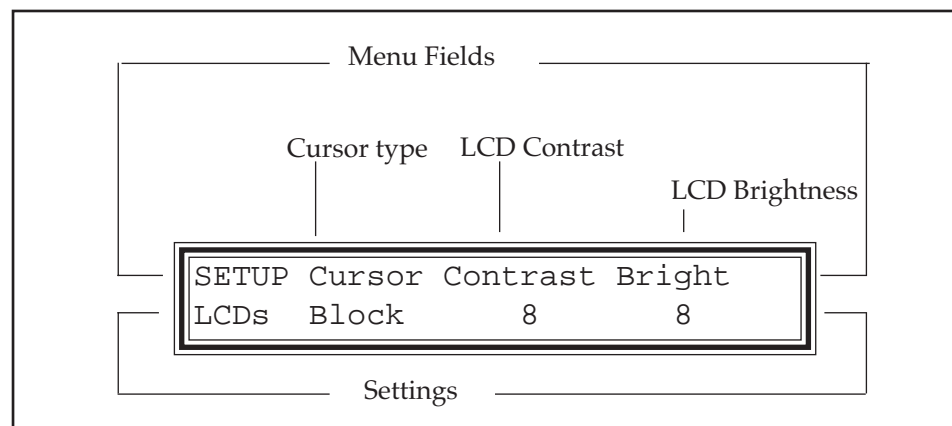

---

## Setup Util

The SETUP UTIL (Utility) menu is used to configure various ESP II controls to suit your preferred operating method. To open the Util menu, press the SETUP button, move the cursor to the UTIL field and press the ON (+) key, the menu consists of four fields as follows:

### P1/2

Many operators who use the Preset faders while running a show prefer to move the 2 Preset Master faders together, with one hand, to crossfade between Presets. To allow this on an ESP II the Preset 2 Master fader can be reversed such that at the top of its travel output from Preset 2 is zero (0) and at the bottom of its travel the output is 100%.

To change the P1/2 field to REV (Reverse) move the cursor to the P1/2 field and press the Plus (+) button. Pressing the Plus (+) button again will toggle between NORM (Normal) and REV (Reverse)

### D.B.O. (Dead Black Out)

The DBO button can be set to either momentary or latching operation. To alter DBO operation move the cursor over the DBO field and press either the On (+) or Off (-) key. The possible settings are:

#### Momt

Momentary operation, the console is Blacked Out only while the DBO button is held depressed.

#### Ltch

Latching, the console is Blacked Out by pressing the DBO button. Output is restored when the DBO button is pressed again.

The Setup Utilities Menu

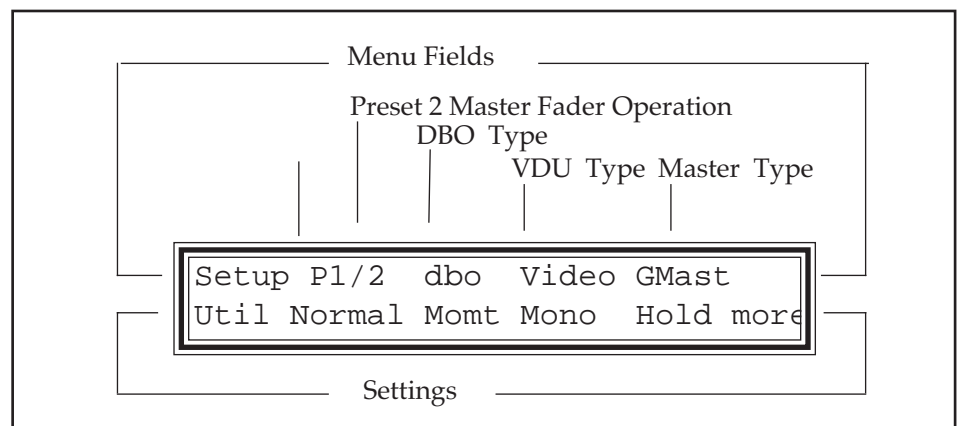

---

## Setup Util

### Video

An optional panel is available which allows a Video monitor to be connected to the console. The Video field is used to configure the ESP II output to suit a variety of different monitor types. To change the Video field move the cursor over the VIDEO field and press either the On (+) or Off (-) key. The possible settings are:

- Mono To suit monochrome monitors
- CGA To suit monitors designed for a Composite Graphic Adaptor
- EGA To suit monitors designed for a Extended Graphic Adaptor

### GMaster

This field is used to set the operation of the Grand Master fader. To change setting move the cursor over the GMAST field and press either the Plus (+) or Minus (-) key. The possible settings are:

- Scn - The fader scales the level of the Scene Masters
- All - The fader scales all console outputs except the Flash buttons.

Infade (move the cursor to the More field to open this field)

Sets the default Infade time. This time will be automatically applied to all cues (XF:Q) as they are recorded.

Infade time can be set anywhere in the range 0 to 99 minutes 59 seconds. The infade time determines how long it will take for the Q to fade from zero to 100%

Outfade (move the cursor to the More field to open this field)

Sets the default Outfade time. This time will be automatically applied to all cues (XF:Q) as they are recorded.

Outfade time can be set anywhere in the range 0 up to 99 minutes 59 seconds. The outfade time determines how long it will take for the Q to fade from 100% to zero.

The Setup Utilities Menu

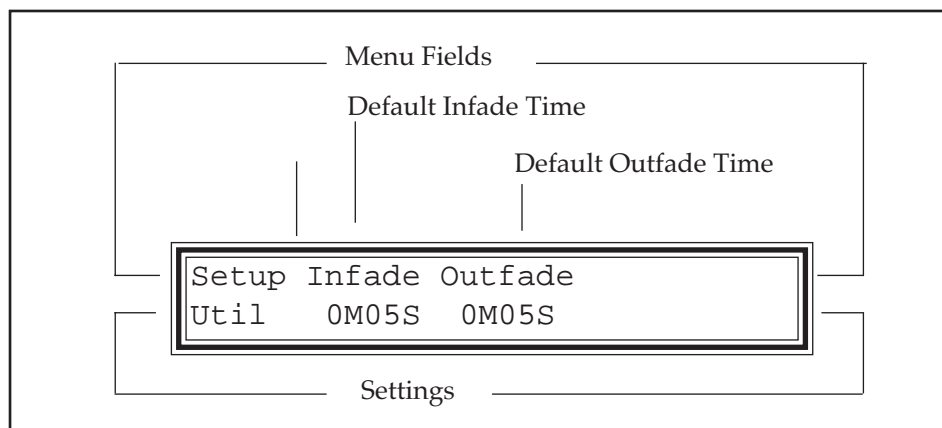



# Setup Midi

The Musical Instrument Digital Interface MIDI is a well established standard which allows communication between suitably equipped devices. The ESP II is equipped with a MIDI input socket which is used to allow Midi control of various console functions. To select the MIDI menu move the cursor to the MIDI field and press the ON (+) key.

## Midi

The Midi field must be turned ON for Midi to be used. The Midi interface can be configured (using the other menu fields) to suit your requirements and then turned On and Off as required.

## Midi-Ch (Channel)

MIDI information can be broadcast on any of 16 channels, to set which channel the ESP II will 'listen' to enter a value between 1 and 16

## Prog (Midi Program Change Messages)

The ESP II responds to MIDI Program Change information, Program change messages can be used to activate the XF section  
For example if Midi Program Change message 25 is received, XF 1 Q 25 will play on the XF master.

## Scene (Scene Fader Number)

Sets the Scene flash button to be triggered by the Note set in the Note field. Each Scene Master can be set to respond to a different note, to do this step through the Scene field setting each fader to the desired note. The Scene / Note fields update immediately and there is no need to press Record to save changes.

Figure11  
TheMidi Menu

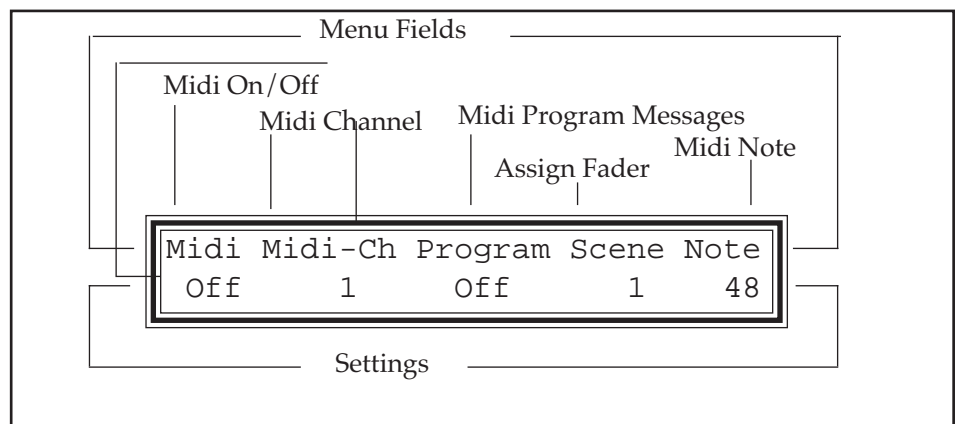

---

## Setup Midi

### Note (Midi Note Message)

Midi allows for 128 Note messages to be broadcast. The NOTE field is used to set which of the 128 Notes will be associated with each of the 12 Scene Masters. Whenever a note that has been specified in this menu is received it will be equivalent to pressing the SCENE Flash button.

First set the Scene field from 1 to 12 and then set the NOTE field from 1 through 128 - corresponding to the 128 Midi Notes.

If you don't want to use Midi NOTE messages on a particular Scene master set the NOTE field to zero (displayed as OFF). To set the field to off, enter a zero or double click on the minus (-) key.

---

## Setup MCard

The ESP II MCard is an optional accessory which allows all the information recorded in the console to be saved to a compact ramdisk. Anyone who regularly runs the same show is strongly advised to fit an MCard. It is not possible to access the MCard menu unless the console is fitted with the MCard panel.

### The MCard Menu

To open the MCard menu move the cursor to the MCard field and press the + key. The menu contains 2 fields:

#### To MCard

To select this option and save the desk data To the Mcard move the cursor to the TO MCARD field and press the Plus (+) key.

#### From MCard

To select this option and load data to the desk move the cursor to the FROM MCARD field and press the Plus (+) key.

#### Saving to the MCard.

To save the information recorded in the ESP II follow these steps.

1. Insert a MCard in the rear panel slot, ensure that the MCard battery is fitted and the write enable switch is on
2. Open the MCARD menu as detailed above.
3. Move the cursor to the TO MCARD field and press +
4. A record confirmation screen shows.

#### Loading from the MCard.

When information is loaded from a MCard all Scenes, Chases and Patches are overwritten.

To retrieve information recorded on a MCard to the ESP II , follow these steps.

1. Insert the recorded MCard in the rear panel slot, ensure that the MCard battery is fitted and the write enable switch is on
2. Open the MCARD menu as detailed above.
3. Move the cursor to the FROM MCARD field and press +
4. A loaded confirmation screen shows.

## IMPORTANT

Insert the M-Card only when transferring data

The M-Card may be corrupted if the desk is turned on or off with the M-Card in the console.

---

## Working with Scenes

The ESP II can record 10 Pages of 12 Scenes each for a total of 120 Scenes.

*Note:*

*Scenes can only be recorded when the desk is set to RECORD mode.*

### Setting the Page Number

- Use the arrow buttons to move the cursor to the Page field.
- Use the Plus (+) and Minus (-) buttons to set the required Page number.

### Freeze

When the Page field is flashing it indicates that the Page number has been changed while a Scene Master was set above zero. That fader will not change to the new Page until it is faded to zero.

### The Scene Controls

There are 12 Scene Master faders and 12 Flash buttons

#### Fader

The fader controls the level of the level of a Scene ranging from 0 to 100%.

#### Flash Buttons

These buttons correspond to the Scene faders and perform two functions:

- 1 Flash. The buttons are used to momentarily flash on a Scene.
- 2 Record. To Record a Scene, set up the desired output, hold the Record button down and press a Scene Flash button.

#### LCD Display

The display shows the current Page number

#### Recording a Scene - Record and Point

- Use the arrow buttons to move the cursor to the Page field.
- Use the Plus (+) and Minus (-) buttons to set the required Page number.
- Use the Preset faders (and any other console controls) to set up the lighting output required.
- Hold the Record button down and press the Flash button (beneath the Scene fader)\*.
- A message displays on the LCD showing the number of items recorded and how many are still available.
- Release both buttons.

---

# Working with Scenes

**NB**

\* If the LED in the Flash button comes on when the Record button is pressed that scene has already been recorded. Proceeding will record over the old scene.

**More Information**

Pg 30      Editing an Scene

Pg 30      Blind Recording using the EDIT SCENE menu.

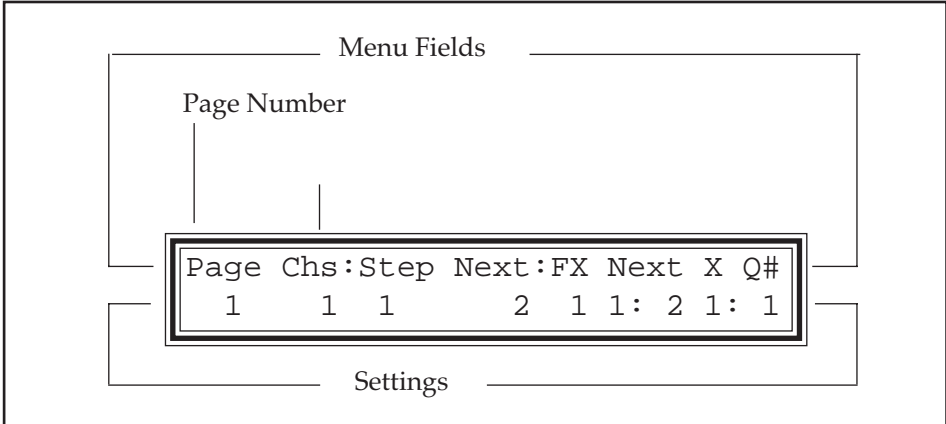

---

## Editing a Scene

### Editing a Scene

A Scene can be edited to change the levels of channels or groups of channels. Editing can be carried out 'blind', that is, without the changes being seen on stage or 'live'.

*Note:*

*The Edit Scene menu is only available when the desk is set to RECORD mode.*

- Hold the EDIT button down and press the Scene Flash button.
- Either use the Preset 1 (top preset) faders to set new levels or enter Channel numbers and levels directly into the Edit Scene menu. For detailed explanations of this step refer to the Edit Scene Menu section below.
- When all changes have been made press the RECORD button.
- A message displays on the LCD showing the number of items recorded and how many are still available for future recording.

N.B.

Whenever the EDIT SCENE menu is opened the Preset faders are disabled from outputting to the stage. However they can be used to set levels for the item being edited.

### Recording Changes made in Edit

To save the changes made using EDIT press the RECORD button. It is **not** necessary to press record after each channel (or group of channels) is set to a new level.

### Live and Blind Editing

The ESP II allows edits to be carried out Live or Blind. An edit will be Live if that Scene is currently being outputted to the Stage (by one of the Scene Masters) otherwise it will be blind.

### Editing a Scene not on the current Page

It's possible to blind Edit a Scene which is not currently on the Scene Masters.

- Hold the EDIT button down and press ANY Scene Flash button.
- Move the cursor to the PG field and set the required Page number.
- Move the cursor to the SC field and set the required Scene number.
- Use the procedure described above to perform a blind edit

### The Edit Scene Menu

The illustration below shows the EDIT SCENE menu. There are 5 fields in the Scene menu:

## Editing a Scene

- PG:** (Page Number)  
Page number sets the Page of the Scene to be edited. To change this number move the cursor to The PG: field and use the Plus (+) and Minus (-) buttons to change the number.
- SC:** (Scene Number)  
Sets the Scene to be edited. To change this number move the cursor to The SC: field and use the Plus (+) and Minus (-) buttons to change the number.
- CH** (Channel)  
Can be set using the Plus (+) and Minus (-) buttons or by moving any of the TOP preset faders. Moving a top preset (P1) fader sets the channel (CH) field to that number.
- TO** Can only be changed by using the Plus (+) and Minus (-) buttons (the slider method is not available). Changes to level will effect all channels from the CH number to the TO number, inclusive.
- AT** Used to set a new level for the Channel or channels set by the CH and TO fields. AT can be changed by using the Plus (+) and Minus (-) buttons or by moving the TOP preset fader until its level matches the previously recorded level. Once a match has been acheived the slider takes control of the level and can be used to set the AT field.  
For the slider to ‘take control’ of a channel recorded at Zero level (AT=0) it is necessary to move the slider above zero, to select the channel, then back to zero to match the level, then to the new level setting.

TheEdit Scene Menu

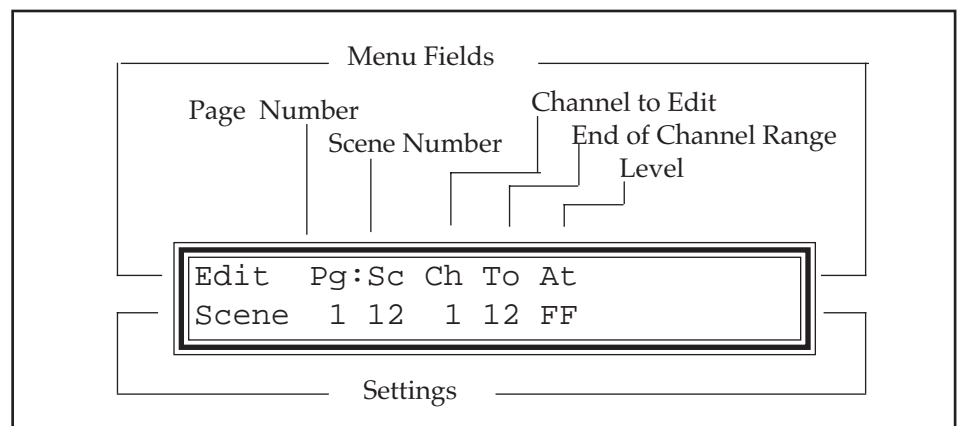

---

## Working with Chases

The ESP II can record 10 Chases numbered 0 - 9.

### Setting the Chase Number

- Use the arrow buttons to move the cursor to the Chase field.
- Use the Plus (+) and Minus (-) buttons to set the required Chase number.

### Freeze

When the Chase field is flashing it indicates that the Chase number has been changed while the old Chase was set above zero. That fader will not change to the new Chase until it is faded to zero.

### The Chase Controls

Are used to set the speed, direction and level of the Chase number displayed in the LCD window. Once a Chase is set it can be Assigned to a Scene Master.

### Fader

The fader controls the level of the chase ranging from 0 to 100%.

### Flash Button

The Flash button, when pressed, resets the Chase to step 1 and runs the Chase from the first to the last step. The Flash Master switch must be in the ADD, ADD LATCH or SOLO position and the Chase level will be dependent on the setting of the Flash master fader.

### Rate

The Rate pot can be used to speed up or slow down a Chase. Turning it fully counter clockwise will slow the chase to a STOP, turning it fully clockwise will increase the speed to the maximum speed.

### Chase Direction

The Direction button is used set the direction of the Chase. Push the button to change the setting. With each press of the button the direction changes to one of the following:

- >> - Forward Green Led On
- <> - Bounce Both Leds On
- << - Reverse Red Led On
- Rn - Random Neither Led On



---

## Working with Chases

### Single Stepping a Chase

To single step a Chase, first reduce the chase speed to zero (0) by turning the rate override pot fully counter clockwise. Then use the Flash button to step the Chase.

### Assign

The Assign button is used to Assign (or transfer) a Chase to the control of a Scene Master. Press the Assign button then press a Scene Master Flash button, the Chase is assigned to that fader. The Chase speed and direction should be set before assigning as the Scene controls only provide control of level.

To Unassign a Chase from a Scene master press and hold the Exit button while pressing that Scene master flash button.

### Recording a Chase - Record and Point

- Use the arrow buttons to move the cursor to the Chase field.
- Use the Plus (+) and Minus (-) buttons to set the required Chase number.
- Use the Preset faders (and any other console controls) to set up the lighting output required for the first step of the Chase.
- Hold the Record button down and press the Flash button (beneath the Chase fader).
- A message displays on the LCD showing the number of items recorded and how many are still available.
- Release both buttons.
- Set up the output required for the second step of the Chase.
- Hold the Record button down and press the Flash button (beneath the Chase fader).
- A message displays on the LCD showing the number of items re-

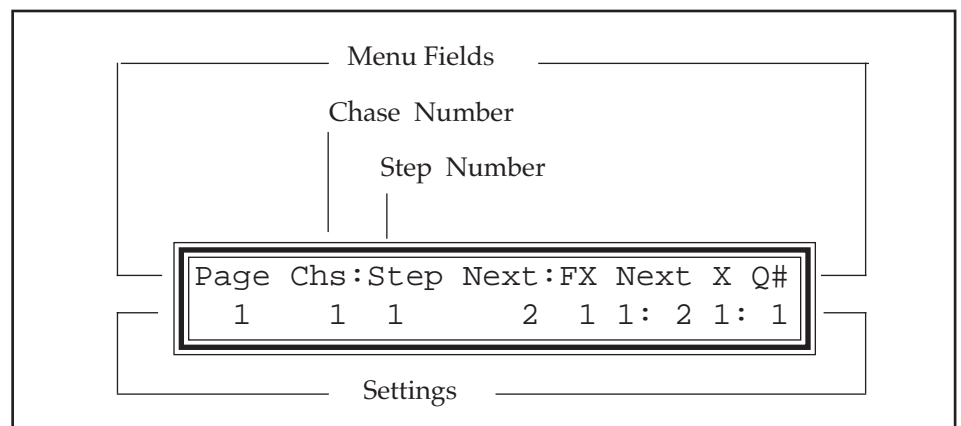

- 
- corded and how many are still available.
- Release both buttons.
  - Repeat the last three steps for each subsequent step of the Chase.

**NB**

- \* When the Record button is pressed, the Chase STEP field stops counting and automatically changes to allow a new step to be added.

**Setting the Chase Step to Record**

It is possible to record over an existing Chase step by stopping the Chase.

- Use the Rate control to stop the Chase. (Turn fully counter clockwise)
- Use the Chase flash button to Step the Chase to the required step
- Use the Preset faders (and any other console controls) to set up the lighting output required for the first step of the Chase.\*
- Use the Preset faders (and any other console controls) to set up the lighting output required
- Hold the Record button down and press the Flash button (beneath the Chase fader).
- A message displays on the LCD showing the number of items recorded and how many are still available.
- Release both buttons.

**NB**

- \* If the Chase fader is up any changes will be added to the old step. To completely replace the step ensure the Chase fader is at zero when recording.

**More Information**

Pg # Editing a Chase

Pg # Blind Recording using the EDIT CHASE menu.

---

## Editing a Chase

### Editing a Chase

A Chase can be edited to change the levels of channels or groups of channels. Editing can be carried out 'blind', that is, without the changes being seen on stage or 'live'.

- Stop the Chase on the Step to be edited.
- Hold the EDIT button down and press the Chase Flash button.
- Either use the Preset 1 (top preset) faders to set new levels or enter Channel numbers and levels directly into the Edit Chase menu. For detailed explanations of this step refer to the Edit Chase Menu section below.
- When all changes have been made press the RECORD button.
- A message displays on the LCD showing the number of items recorded and how many are still available for future recording.

N.B.

Whenever the EDIT CHASE menu is opened the Preset faders are disabled from outputting to the stage. However they can be used to set levels for the item being edited.

### Recording Changes made in Edit

To save the changes made using EDIT press the RECORD button. It is **not** necessary to press record after each channel (or group of channels) is set to a new level.

### Live and Blind Editing

The ESP II allows edits to be carried out Live or Blind. An edit will be Live if that Chase is currently being outputted to the Stage otherwise it will be blind.

### Editing a Chase not on the Chase Master

It's possible to blind Edit a Chase which is not currently on the Chase Master.

- Hold the EDIT button down and press the Chase Flash button.
- Move the cursor to the CHS: field and set the required Chase number.
- Move the cursor to the ST field and set the required Chase Step number.
- Use the procedure described above to perform a blind edit

### Adding a Step

- Set the ST (step) field to the step number that you wish to add.

---

## Editing a Chase

*Note:*  
The Edit Chase menu is only available when the desk is set to RECORD mode.

When a step is added it pushes all the old steps which had an equal or higher number one number higher. For example when adding a new first step set ST to 1. The old step 1 will become step 2, the old step 2 will become 3 and so on.

- Move the cursor to the ADD field and press the ON (+) button.
- Press the ON (+) button again to confirm the Add.  
**Note - Adding the step does NOT record any levels.**
- After adding the step either use the faders or the CH and AT fields to set the required Channel levels
- Press RECORD.

### Deleting a Step

- Set the ST (step) field to the step number that you wish to remove.
- Move the cursor to the DEL field and press the ON (+) button.
- Press the ON (+) button again to confirm the Delete.
- Press Exit to close the menu.

### The Edit Chase Menu

The illustration over shows the EDIT CHASE menu. There are 5 fields in the Chase menu:

CHS: (Chase Number)

Sets the Chase to be edited. To change this number move the cursor to The CHS: field and use the Plus (+) and Minus (-) buttons to change the number.

ST (Step)

Sets the Step to be edited.

OF (Number of Steps)

Indicates how many steps recorded in this Chase

CH (Channel)

Can be set using the Plus (+) and Minus (-) buttons or by moving any of the TOP preset faders. Moving a fader sets the channel (CH) field to that number.

TO Can only be changed by using the Plus (+) and Minus (-) buttons (the slider method is not available). Changes to level will effect all channels from the CH number to the TO number, inclusive.

AT Used to set a new level for the Channel or channels set by the CH

## Editing a Chase

and TO fields. AT can be changed by using the Plus (+) and Minus (-) buttons or by moving the TOP preset fader until its level matches the previously recorded level. Once a match has been achieved the slider takes control of the level and can be used to set the AT field.

For the slider to 'take control' of a channel recorded at Zero level (AT=0) it is necessary to move the slider above zero, to select the channel, then back to zero to match the level, then to the new level setting.

### ADD (Add)

The ADD field is used to Add a step to a chase. Move the cursor to the ADD field and press ON (+).

### DEL (Delete)

The DEL field is used to delete a step to a chase. Move the cursor to the DEL field and press ON (+).

Figure 21  
The Edit Chase Menu

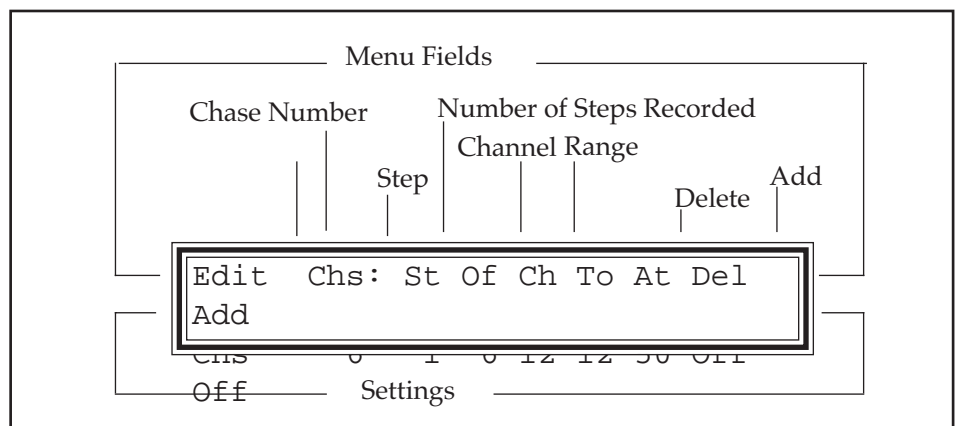

---

## Working with FX

Console output can be recorded to the FX section in the same way as Scenes are recorded. Up to 100 FX, which are intended for controlling colour scrollers or other effects, can be recorded and then played back in any order.

### **The FX Controls**

#### **Fader**

The fader controls the level of the FX output ranging from 0 to 100%.

#### **Flash Button**

This button corresponds to the FX fader and performs two functions:

- 1 GO. The button is used to step through the recorded FX numbers.
- 2 Record. To Record an FX, set up the desired output, hold the Record button down and press the FX Flash button.

#### **LCD Display**

The display above the FX fader shows the current FX output number and the Next FX Press the flash button to activate the Next FX.

#### **Recording a FX - Record and Point**

- Use the arrow buttons to move the cursor to the FX field.
- Use the Plus (+) and Minus (-) buttons to set the FX number.
- Use the Preset faders (and any other console controls) to set up the lighting output required.
- Hold the Record button down and press the FX Flash button (beneath the FX fader).
- A message displays on the LCD showing the number of items recorded and how many are still available.
- Release both buttons.

#### **Changing the Playback Order**

FX play back in numerical sequence, FX 2 follows FX 1 and so on. Any unrecorded number is ignored, so if only FX 10, 20, 30, 40 are recorded, pressing the flash button will step through 10, 20, 30, 40 and then loop back to 10. To change the order:

- Use the arrow buttons to move the cursor to the NEXT FX field.
- Use the Plus (+) and Minus (-) buttons to set the required FX number.

---

# Working with FX

- Press the FX Flash button.

## More Information

Pg 40 Blind Recording using the EDIT FX menu.

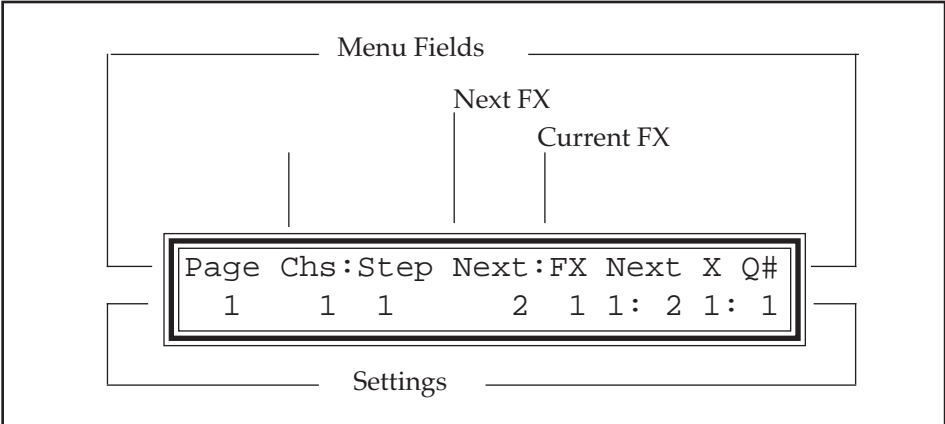

---

## Editing FX

### Editing a FX

A FX can be edited to change the levels of channels or groups of channels. Editing can be carried out 'blind', that is, without the changes being seen on stage or 'live'.

- Hold the EDIT button down and press the FX Flash button.
- Either use the Preset 1 (top preset) faders to set new levels or enter Channel numbers and levels directly into the Edit FX menu. For detailed explanations of this step refer to the Edit FX Menu section below.
- When all changes have been made press the RECORD button.
- A message displays on the LCD showing the number of items recorded and how many are still available for future recording.

N.B.

Whenever the EDIT FX menu is opened the Preset faders are disabled from outputting to the stage. However they can be used to set levels for the item being edited.

### Recording Changes made in Edit

To save the changes made using EDIT press the RECORD button. It is **not** necessary to press record after each channel (or group of channels) is set to a new level.

### Live and Blind Editing

The ESP II allows edits to be carried out Live or Blind. An edit will be Live if that FX is currently being outputted to the Stage (by the FX Master) otherwise it will be blind.

### Changing the FX number to Edit

It's possible to blind Edit a FX which is not currently on the FX Masters.

- Hold the EDIT button down and press the FX Flash button.
- Move the cursor to the FX field and set the required FX number.
- Use the procedure described above to perform a blind edit

### The Edit FX Menu

The illustration below shows the EDIT FX menu, press the EDIT button followed by the FX button to see this menu. There are 4 fields in the FX menu:

FX: (FX Number)

Sets the FX to be edited. To change this number move the cursor



to The FX: field and use the Plus (+) and Minus (-) buttons to change the number.

CH (Channel)

Can be set using the Plus (+) and Minus (-) buttons or by moving any of the TOP preset faders. Moving a fader sets the channel (CH) field to that number.

TO Can only be changed by using the Plus (+) and Minus (-) buttons (the slider method is not available). Changes to level will effect all channels from the CH number to the TO number, inclusive.

AT Used to set a new level for the Channel or channels set by the CH and TO fields. AT can be changed by using the Plus (+) and Minus (-) buttons or by moving the TOP preset fader until its level matches the previously recorded level. Once a match has been acheived the slider takes control of the level and can be used to set the AT field.

For the slider to 'take control' of a channel recorded at Zero level (AT=0) it is necessary to move the slider above zero, to select the channel, then back to zero to match the level, then to the new level setting.

Figure 20  
The Edit FX

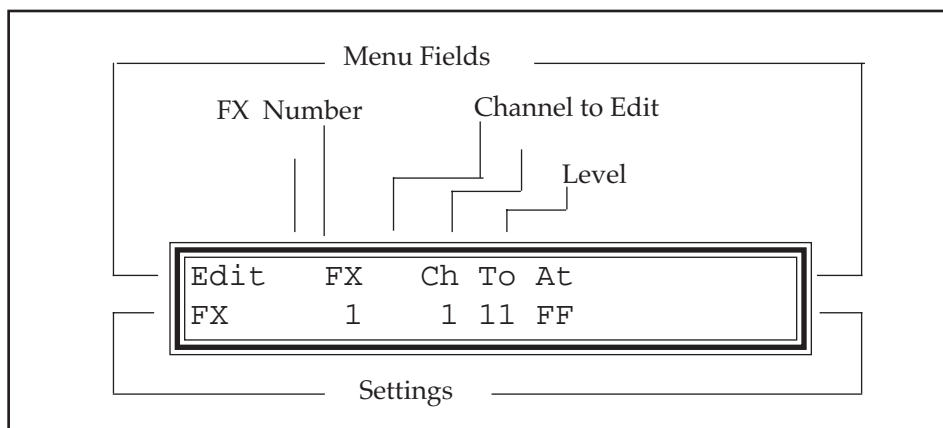

---

## Working with XF Cues

Console output can be recorded to the crossfade (XF) section in the same way as Scenes are recorded. There are 10 XF stacks each comprising 100 cue (Q) numbers.

### *Note:*

*The Chase menu is only available when the desk is set to RECORD mode.*

### **The XF Controls**

#### Fader

The fader is used to take manual control of a crossfade. The fader should be fully up (at the 10 position) for the crossfade to run normally.

#### Flash Button

This button corresponds to the XF fader and performs two functions:

- 1 GO. The button is used to begin a crossfade.
- 2 Record. To Record a Q, set up the desired output, hold the Record button down and press the XF Flash button.

#### LCD Display

The display above the XF fader shows the current XF stack / Q number and the Next XF / Q number. Press the flash button to begin a timed dipless crossfade from one to the other. When a crossfade is running the display shows the time to run in seconds and the elapsed fade percentage. If the display shows 5 / 50% it indicates that there is 5 seconds to run and the fade is 50% complete.

### **Recording a Q - Record and Point**

- Use the arrow buttons to move the cursor to the XF field.
- Use the Plus (+) and Minus (-) buttons to set the XF number.
- Use the arrow buttons to move the cursor to the Q field.
- Use the Plus (+) and Minus (-) buttons to set the Q number.
- Use the Preset faders (and any other console controls) to set up the lighting output required.
- Hold the Record button down and press the XF Flash button (beneath the XF fader).
- A message displays on the LCD showing the number of items recorded and how many are still available.
- Release both buttons.

### **Changing the Playback Order**

Qs play back in numerical sequence, XF/Q 1:2 follows XF/Q 1:1 and so on. Any unrecorded number is ignored, so if only XF/Q 1:10, 1:20, 1:30, 1:40 are recorded, each press of the flash button will fade from 1:10 to 1:20 to 1:30 to 1:40 and then loop back to 1:10. To change the order:

- Use the arrow buttons to move the cursor to the NEXT XF/Q field.

---

## Working with XF Cues

- Use the Plus (+) and Minus (-) buttons to set the required XF/Q number.
- Press the FX Flash button.

### Taking Manual Control of a Fade

To take manual control of a crossfade move the fader to match the elapsed fade percentage. The display changes to show MAN: / 20% (or whatever fade percentage has elapsed)

The fader can now be moved up or down to control the progress of the fade. If the level is taken to 100% the fade is completed and the fader reverts to level control.

To take manual control from the beginning of the cue pull the fader down to zero (0) before pressing the flash button

Leaving the fade under manual control means that all subsequent cues will come under manual control when the fade percentage reaches the fader setting. Thus if XF/Q 1:10 was taken under control after 50% of the fade time had elapsed it would stay on at 50%. If the fader was left at this level the next press of GO would cause the next Q to fade to 50% and XF/Q 1:10 to fade from 50% to 25% (i.e. 50% of 50%).

### Fade Times

The default fade time, normally 5 seconds, is set in the SETUP UTIL menu, all Qs are recorded with this Infade and Outfade time. However fade times can be changed for each Q by using the EDIT XF menu.

### More Information

Pg 44 Blind Recording using the EDIT XF menu.

Pg 44 Setting fade times using the EDIT XF menu.

Pg 24 Setting the default fade times.

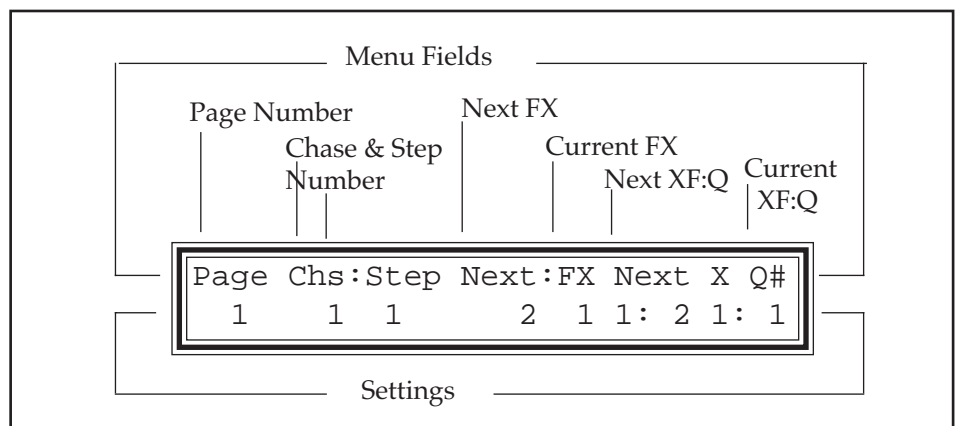

---

## Editing a XF Cue

### Editing a Crossfade Cue

A Crossfade (XF) Cue (Q) can be edited to change the levels of channels or groups of channels. Editing can be carried out 'blind', that is, without the changes being seen on stage or 'live'.

- Hold the EDIT button down and press the XF Flash button.
- Either use the Preset 1 (top preset) faders to set new levels or enter Channel numbers and levels directly into the Edit XF Q menu. For detailed explanations of this step refer to the Edit XF Q Menu section below.
- When all changes have been made press the RECORD button.
- A message displays on the LCD showing the number of items recorded and how many are still available for future recording.

N.B.

Whenever the EDIT XF Q menu is opened the Preset faders are disabled from outputting to the stage. However they can be used to set levels for the item being edited.

### Recording Changes made in Edit

To save the changes made using EDIT press the RECORD button. It is **not** necessary to press record after each channel (or group of channels) is set to a new level.

### Live and Blind Editing

The ESP II allows edits to be carried out Live or Blind. An edit will be Live if that XF Q is currently being outputted to the Stage (by one of the XF Q Masters) otherwise it will be blind.

### Editing a XF Q not on the current Page

It's possible to blind Edit a XF Q which is not currently on the XF Q Masters.

- Hold the EDIT button down and press the XF Q Flash button.
- Move the cursor to the XF field and set the required XF number.
- Move the cursor to the Q# field and set the required XF Q number.
- Use the procedure described above to perform a blind edit.

### Changing Fade Times

Fade times can be changed at any time without re-recording the Scene.

- Open the Edit XF Q menu
- Use the arrow buttons to move the cursor to the Infade field.

## Editing a XF Cue

- Enter an Infade time of up to 99Minutes 59Seconds using the + and - buttons to change the existing value.
- Use the arrow buttons to move the cursor to the Outfade field.
- Enter an Outfade time of up to 99Minutes 59Seconds using + and - buttons to change the existing value.
- Press the EXIT button.
- Do NOT press the Record button, if only entering or changing the fade times.

### The Edit XF Q Menu

The illustration below shows the EDIT XF Q menu. There are 5 fields in the XF Q menu:

- XF:** (Crossfade Stack Number)  
Sets the Stack number of the Q to be edited. To change this number move the cursor to The XF: field and use the Plus (+) and Minus (-) buttons to change the number.
- Q:** (XF Q Number)  
Sets the Q to be edited. To change this number move the cursor to The Q#: field and use the Plus (+) and Minus (-) buttons to change the number.
- CH** (Channel)  
Can be set using the Plus (+) and Minus (-) buttons or by moving any of the TOP preset faders. Moving a fader sets the channel (CH) field to that number.
- TO** Can only be changed by using the Plus (+) and Minus (-) buttons (the slider method is not available). Changes to level will effect all channels from the CH number to the TO number, inclusive.

Figure 20  
The Edit Xf Cue

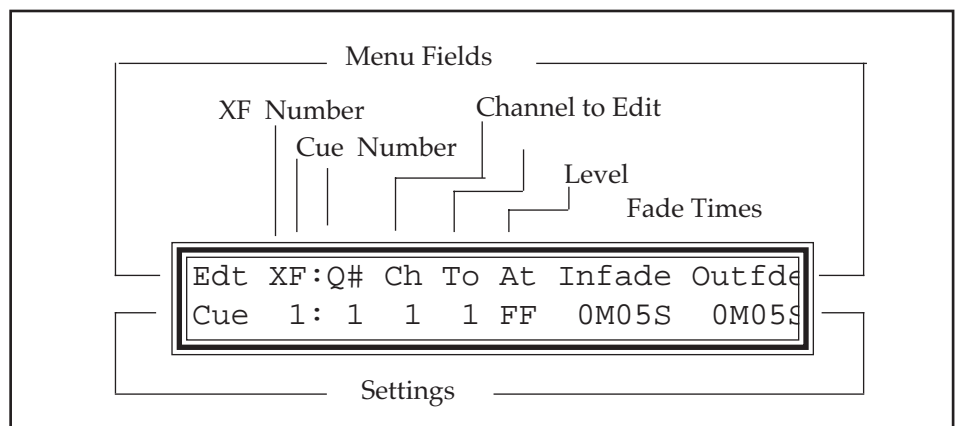

---

## Editing an Xf Cue

**AT** Used to set a new level for the Channel or channels set by the CH and TO fields. AT can be changed by using the Plus (+) and Minus (-) buttons or by moving the TOP preset fader until its level matches the previously recorded level. Once a match has been achieved the slider takes control of the level and can be used to set the AT field.  
For the slider to 'take control' of a channel recorded at Zero level (AT=0) it is necessary to move the slider above zero, to select the channel, then back to zero to match the level, then to the new level setting.

### Infade (Infade Time)

Infade time can be set anywhere in the range 0 to 99 minutes 59 seconds. The infade time determines how long it will take for the Q to fade from zero to 100%

### Outfade (Outfade Time)

Outfade time can be set anywhere in the range 0 up to 99 minutes 59 seconds. The outfade time determines how long it will take for the Q to fade from 100% to zero.

---

# Reset

Reset is used to reset the console and optionally clear all data including Scenes, Chases, FX, XF, and Patches. Reset can be used to quickly erase all data that has been recorded in an ESP II.

## To Reset the console

- Hold the DBO and FLASH Master buttons down while turning power on to the console.
- Press the RECORD button to confirm the console Reset.
- All data is cleared from the console and all settings revert to the factory set defaults.

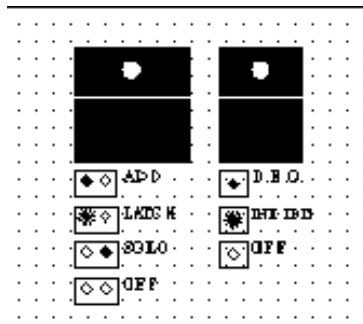

```
Reset      ALL Data will be lost!!
Console   RECORD to confirm
```

---

## Appendix 1 - Pin Assignments

### DMX Digital Output Socket

PIN No	Signal
1	SHIELD
2	SIGNAL -
3	SIGNAL +
4	NOT USED
5	NOT USED

Connector type: Cannon 5 pin XL  
**RS-485 Standard USITT DMX-512 Protocol**

### Midi In Socket

PIN No	Signal
1	NOT USED
2	NOT USED
3	NOT USED
4	MIDI +
5	MIDI SIGNAL

Connector type: Din 5 pin

### Desklight Socket

PIN No	Signal
1	No Connection
2	Ground
3	0 - 12 volts +

Connector type: Cannon 3 pin XL



---

## Desk Link Cable

To link two ESP II consoles together connect a cable, wired as detailed below between the DMX output of the desk to be the slave to the MIDI input on the desk to be used as Master.

Cannon 5 Pin	Din 5 Pin
PIN No	PIN No

2	—	390R 1/4w 5%	—	4
4	—		—	5

## Power

Requirements	90 volts to 265 volts AC, 50-60 Hz
Consumption	40 watts (85 watts with analog outputs)
Connector	IEC 3-pin inc. fuse, switch and mains filter
Fuse	2 amp M205

## Midi Note Messages

Midi Note messages run from 0 to 127.

Midi Note	Midi Note	Midi Note	Midi Note	Midi Note	Midi Note
36 C1	48 C2	60 C3	72 C4	84 C5	96 C6
37 C#1	49 C#2	61 C#3	73 C#4	85 C#5	97 C#6
38 D1	50 D2	62 D3	74 D4	86 D5	98 D6
39 D#1	51 D#2	63 D#3	75 D#4	87 D#5	99 D#6
40 E1	52 E2	64 E3	76 E4	88 E5	100 E6
41 F1	53 F2	65 F3	77 F4	89 F5	101 F6
42 F#1	54 F#2	66 F#3	78 F#4	90 F#5	102 F#6
43 G1	55 G2	67 G3	79 G4	91 G5	103 G6
44 G#1	56 G#2	68 G#3	80 G#4	92 G#5	104 G#6
45 A1	57 A2	69 A3	81 A4	93 A5	105 A6
46 A#1	58 A#2	70 A#3	82 A#4	94 A#5	106 A#6
47 B1	59 B2	71 B3	83 B4	95 B5	107 B6

---

# Index

## A

Add 12  
Add / Solo Master Switch 12  
Add Latch 12  
Adding a Step 35  
Analogue 4  
Assign 33

## B

Black Out) 23  
Blind 35, 40  
Blind Editing 30  
Bright 22

## C

Chase 32  
Chase Controls 7, 32  
Connecting Desklights 4  
Connecting Power 4  
Connecting the Output to a dimmer 4  
Contrast 22  
Crossfade 42  
Cues 42  
Cursor 22

## D

D.B.O. 12, 23  
Deleting a Step 36  
Desk Link Cable 49  
DeskLight 20  
Desklight 8  
Display 15  
DMX 48  
DMX Output 8  
DMX-512 4

## E

Edit Button 14  
Edit File 40  
Edit FX 40  
Editing a Chase 35, 36  
Editing a Cue 44  
Editing a FX 40  
Editing a Scene 30

## F

Fade Times 43, 44  
Fader 42  
Flash Buttons 6, 11  
Flash Master Controls 8  
Flashing LCD 15  
Freeze 15, 28  
FX 38  
FX controls 7  
FX Playback Order 38

## G

Grand Master 8, 12

## I

Inhibit 11

## L

Latching 23  
LCD Display 7  
LCD Window 15  
Left 7  
Left arrow 14  
Link 19  
Ltch 23

## M

Manual Control of a Fade 43  
Master 20  
MCard 27  
Midi 8, 25  
Mode 19  
Momentary 23  
Momt 23

## N

Note 26

## O

Off 14  
On 14

## P

P1 and P2 Faders 12  
P1 and P2 Masters 8  
P1/2 23  
Page 28  
Pin Assignments 48  
Playback Order 38  
Power Input 8  
Preset Faders 6, 10  
Prog 25  
Psets 20

## Q

Q number 42

## R

Rate 32  
Recording a Scene 28  
Reset 47  
Reverse 23  
Right 7  
Right arrow 14

## S

Scene Flash Buttons 7  
Scene Master Faders 7  
Scenes 28  
Setup 16  
Setup Button 14  
Setup Desk 19  
Setup LCDs 22  
Setup MCard 27  
Setup Midi 25  
Setup Patch 17  
Setup Util 23  
Single Stepping 33  
Slave 20  
Solo 12

## W

Wide 20

## X

XF Cues 42  
Xfade controls 7

---

---

## Omissions & Additional Information

### **Making a Chase part of a Page**

When a Chase is Assigned to a Scene Master that has not been recorded it will become part of that page. Any time that Page is loaded the Assigned Chase will also load.

If a Scene is subsequently recorded on the Scene master being used to control the Assigned Chase the Chase will no longer form part of that Page.

### **Deleting a Scene, FX, XF Cue.**

To delete a Scene, FX or XF Cue.

- Set the desk output to zero by moving the Grand Master to zero
- Hold the Record button down and press the Flash button (beneath the Scene, FX, XF or Chase fader) of the item to be deleted.
- A message displays on the LCD indicating that the desk output is very low and offering the option of recording zero levels or deleting the item.
- Release both buttons.
- Press the Minus (-) button.
- The item is deleted.

### **Deleting a Chase**

To delete all steps of a Chase

- 1 Hold the EDIT button down and press the Chase Flash button.
- 2 Move the cursor to the SStep field.
- 3 Set the Step number to 1
- 4 Move the cursor to the DELete field.
- 5 Press the Plus (+) button.
  - A warning message is displayed on the LCD
- 6 Press the Plus (+) button again.
  - Note that the Chase is shortened by one step.
  - Repeat steps 5 & 6 until all steps have been deleted.

---